

Overview

EST3 audio design provides the emergency user with an emergency communication package that minimizes switch selections helping the user make simple, accurate and fast evacuation control announcements. EST3 audio builds from standard modules that fit together easily. Audio components use standard EST3 cabinets and power supplies. A single cabinet with audio requires only one 24 V standby battery.

Taking full advantage of digital technology, up to eight channels of audio sources transmit over a single twisted pair of wires between nodes. Coupling the inherent reliability and performance of zoned amplifiers with EST3 simplified user interfaces makes audio system design and operation easy and dependable.

Standard Features

- Eight channels for audio source selection
- Single twisted pair of audio wires between nodes
- VU display shows paging output level
- Ready-to-page LED
- Digital transmission of audio signals
 - greater noise immunity
 - high quality signal transmission
- On board storage of programmed messages and tones
- LCD display of fire phone calls

Audio and Telephone Masters

3-ASU series



Application

EST3 audio is accomplished by selecting modular components for installation in standard fire alarm cabinet assemblies. At the main control panel location mounting audio control equipment provides an emergency user interface for "Paging" and optionally a "Firefighters Master Telephone". Zoned amplifiers mount in the main control panel and/or in remote nodes. By mounting amplifiers in remote nodes, wire runs and space requirements are reduced at the main control panel.

The heart of the EST3 audio package is the Audio Source Unit (ASU). The Audio Source unit converts analog signals to digital signals. Sampling the analog signal 9600 times per second provides high quality reproduction of audio sources. On board audio memory stores signal tones and/or alarm-alert verbal messages. These messages can be digitally recorded in the field using standard PC audio components. The ASU comes standard with two minutes of memory for tone and message storage. Available message memory expands easily to 100 minutes with the optional 3-ASUMX/100 memory expansion card.

Audio Source units support connection of a local microphone, remote microphone, telephone voice line and auxiliary audio input. With eight audio channels to choose from combinations of paging, alert, evacuation signaling and automatic messages are available for simultaneous delivery to different parts of a building.

There are two main audio user interface modules, the paging microphone and the firefighter's telephone. Available individually or in a set, EST3 audio modules open system design possibilities.

When the Life Safety system requires paging only the 3-ASU or 3-ASU/4 Audio Source Units provides a Master Paging microphone with common controls. Switch labeling makes the operation intuitive. Six LEDs and five switches cover paging operations. Three of the five paging switches, All Call, Page to Evacuation, and Page to Alert, cover most paging operations. A VU display shows the user the output level of the page in process. The 3-ASU series mount in one chassis space of a EST3 Lobby enclosure. In addition to the paging microphone the 3-ASU/4 has mounting space for up to four local rail modules, including 20, 40, and 95 watt zone amplifiers and up to four Control Display modules allowing layout flexibility. The 3-ASU provides the same functionality as the 3-ASU/4 but is supplied with an inner door filler plate and no local rail module spaces.

Paging microphone

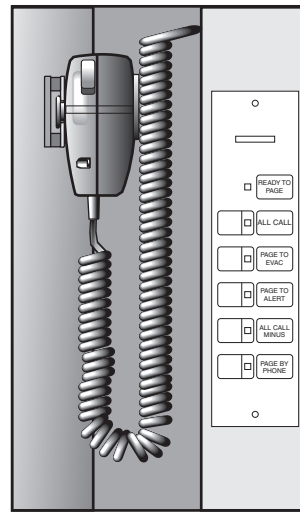

Ready-to-Page LED turns on after the pre-announce tone has finished indicating the system is ready to page.

All Call selects all amplifiers for page delivery.

Page to EVAC selects all amplifiers currently delivering evacuation signaling for page delivery.

Page to ALERT selects all amplifiers currently delivering alert signaling for page delivery.

All Call Minus selects all amplifiers not programmed for alarm signaling for page delivery (typically stairwells).

Page by Phone selects the telephone voice line as the paging source.

Operating the Microphone Talk Key stops alarm signaling to selected zones and starts pre-announce tone delivery.

When the pre-announce tone finishes, the Ready to Page LED turns on.

When system design calls for paging with Firefighters telephone the 3-ASU/FT provides all the paging features of the 3-ASU series with the added benefit of a master handset assembly. The 3-ASU/FT brings to the emergency user easy to understand switches and text messages displaying on a backlit 8 x 20 character LCD display.

Firefighters telephone

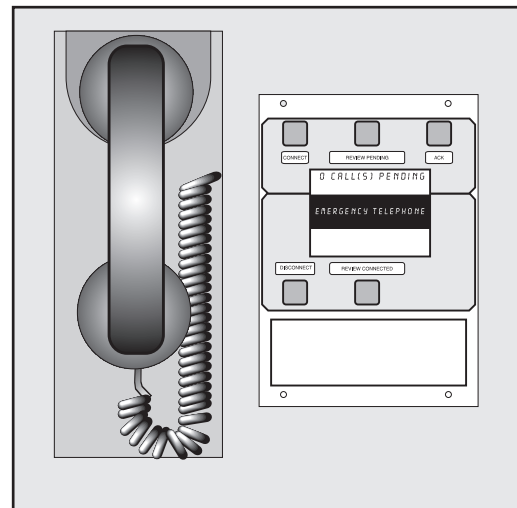

CONNECT switch selects phone circuits shown in the Calls Pending Window.

REVIEW PENDING stops automatic display of pending calls and allows the operator to step through each message at his own pace.

ACK (acknowledge) silences the telephone systems audible signal. The signal resounds for any new call.

DISCONNECT disconnects the highlighted call in the calls connected list.

REVIEW CONNECTED scrolls a reverse highlight through the calls connected list.

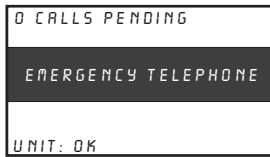

The Firefighters telephone LCD is very similar to the 3-LCD. When there is no active telephone calls the LCD shows a title screen. Active calls display a text message referenc-ing the remote phone location.

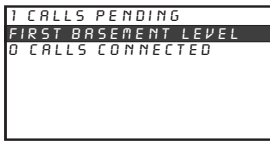

When a remote handset is lifted the LCD display updates to show the calls pending and the call-in signal sounds to alert the user of a pending call.



The user answers the call by pressing the Connect switch. The location message moves from the pending line to the connected line. The call in signal silences. The user simply uses the master telephone to talk with the connected telephone.

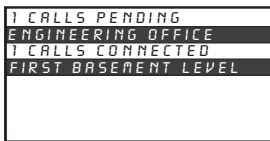

If another call comes in the location message appears in the calls pending line and audible signal resounds. The user can silence the signal by answering the call or by pressing the ACK (acknowledge) switch.

Up to five remote telephone handset assemblies connect to the system simultaneously without any degradation of audio quality.

Engineering Specification

The audio system must provide simultaneous page, alert, and evacuation signals. Systems that cause signaling devices to go silent while performing signaling functions will not be acceptable.

The system must provide operation to 25Vrms or 70.7Vrms speakers. The system must provide as a minimum the following paging common controls and indicators: Ready to page LED, VU display of paging output level, single switch function for paging to all — Alert zones, Evacuation zones, and areas not programmed for signaling. The system must provide high quality analog to digital conversion of paging sources. Digital transmission of paging must be provided between system nodes. The analog sources must be sampled and converted to digital with a sampling rate no less than 9600 samples per second. It must be possible to transmit signal sources (Alert, Alarm, Page, etc.) together over a single pair of wires between nodes.

System amplifiers must be distributed zoned type. Centrally banked systems are not acceptable. An integral circuit for operating traditional NAC devices must be provided with each system amplifier. The circuit must carry a minimum rating of 3.5 Amps for operating 24 Vdc signals.

The system shall provide fully integrated fire fighters' telephone system that shall provide 2-way communication between the fire alarm control panel and any fire fighters' telephone station. The system shall include an alphanumeric user display and controls. When a telephone is activated, a call-in buzzer shall sound, and the location of the phone shall be shown on the alphanumeric display. The display shall be capable of bilingual operation, displaying English, Dutch, Finnish, French, German, Italian, Portuguese or Spanish messages.

The incoming call shall be selected by activating a single button. All subsequent telephone call locations shall be displayed in full text. The system shall display all incoming calls, all connected phone(s) on the alphanumeric display. The system shall be configured so that page messages may be issued from any firefighter's telephone connected to the system, as directed by the emergency operator.

Typical Wiring

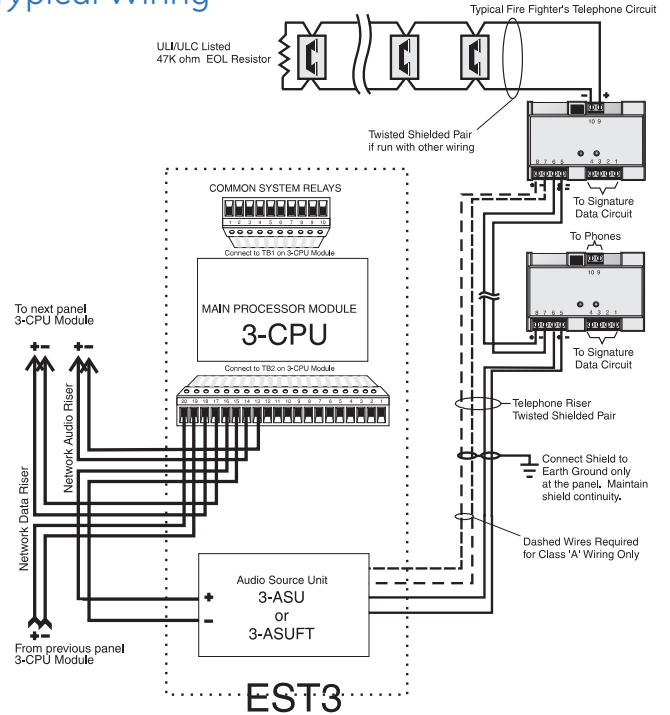

Installation and Mounting

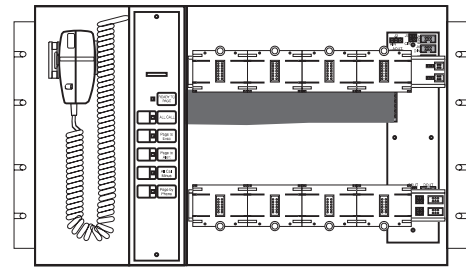

3-ASU/4 has Chassis, Audio Source Unit, Paging Common Control and rail space for four Local Rail Modules. Mounts in EST3 lobby enclosure.

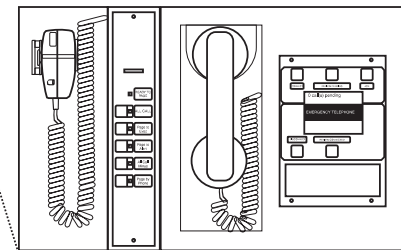
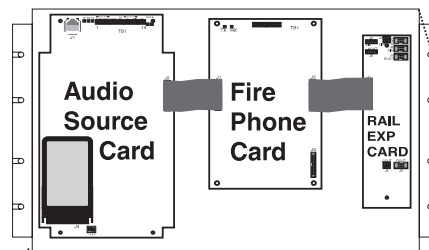

3-ASU/FT has Chassis Assembly /w Audio Source Unit, Paging Common Control and Fire Phone Controls

U.S.
T 888-378-2329
F 866-503-3996

Canada
T 519 376 2430
F 519 376 7258

Asia
T 852 2907 8108
F 852 2142 5063

Australia
T 61 3 9259 4700
F 61 3 9259 4799

Europe
T 32 2 725 11 20
F 32 2 721 86 13

Latin America
T 305 593 4301
F 305 593 4300

www.gesecurity.com

© 2006 General Electric Company
All Rights Reserved

Specifications

Catalog Number	3-ASU	3-ASU/4	3-ASU/FT	3-FTCU
Agency Listings	UL, ULC, FM, CE			
Ambient Temp.	0°C-49°C (32°F-120°F)			
Ambient Humidity	93% Non-condensing @ 32°C			
Mounting	One Chassis Space			
Wire Size	Network Data Riser - 18-12AWG (1.0mm ² -2.5mm ²) Network Audio Riser - 18-12AWG (1.0mm ² -2.5mm ²)		Network Data Riser- 18-12AWG (1.0-2.5mm ²)(3-ASU/FT only) Network Audio Riser- 18-12AWG (1.0-2.5mm ²)(3-ASU/FT only) Telephone Riser - One pair twisted shielded 18 -14 AWG (1.0mm ² to 1.5mm ²)	
Current Rating	210 mA in Alarm and Supervisory		236mA Supervisory 431mA Alarm	26mA Supervisory 221mA Alarm
Audio Inputs	Local Microphone (isolated and supervised); Remote Microphone (isolated and supervised); One auxiliary signal source (isolated)		Local microphone (isolated and supervised); Remote microphone (isolated and supervised); Firefighters' telephone (isolated and supervised); One auxiliary signal source (isolated)	
Pre-recorded Message Storage	Two minutes standard expandable to 100 minutes with optional 3-ASUMX/100. Max. message length 40 seconds.			N/A
Supported Message Count	255			N/A
Auxiliary Input impedance	1K Ohm			N/A
Bilingual Support	English, Dutch, Finnish, French, German, Italian, Portuguese, Spanish			

Telephone Riser		
Active Telephones	N/A	Five Maximum
Wire size	N/A	One pair twisted shielded 18 -14 AWG (1.0mm ² to1.5mm ²)
Line Resistance	N/A	50 Ohm
EOL Resistance	N/A	15K Ohm

Ordering Information

Catalog Number	Description	Ship Wt. lb. (kg)
3-ASU/FT	Audio Source Unit with Local Microphone and Firefighters Telephone.	20 (9.1)
3-ASU/4	Audio Source Unit w/Local Microphone. Provides four local rail spaces.	15 (6.8)
3-ASU	Audio Source Unit w/Local Microphone. Inner door filler plate	15 (6.8)
3-FTCU	Firefighters Telephone Control Unit inner door filler plate.	15 (6.8)
3-ASUMX/100	Audio Source Unit Memory Expansion. Provides 100 minutes of message time.	0.5 (.23)
RFK1	Ferrite Clamp Kit required for EN-54 compliance	.25 (.11)
3-LKE	UK English Label Kit	.25 (.11)
3-LKF	French Label Kit	.25 (.11)
3-LKR	Russian Label Kit	.25 (.11)
3-LKS	Spanish Label Kit	.25 (.11)



imagination at work